

LITE

Decorative Lighting



*LITE is a 24V DC low voltage aluminium profile.
It is an ideal solution for small showcases, homes, rest areas,
museums, hotels, exhibition halls and generally for many
decorative and architectural projects.*

Technical Features

- Aluminium body, painted electrostatically in selected colour.
- With low voltage 24V DC micro track.

Tracking Lights

- With low voltage 24V DC adapter for mounting on LV micro track max. 10A (for linear parts) or max. 6A (for bented parts).
- Pure light without IR/UV radiation.
- Efficient thermal management.
- Operation life: 50,000 hours with efficiency > 80% of the initial luminous flux (L80B10).

Upon Request

- Available also in 2700 Kelvin CRI 90.
- At different shapes and dimensions.

LITE

LITE 1 TWO WAY



LITE 2 TWO WAY

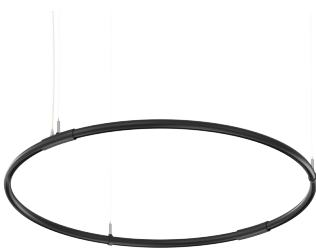

LITE 3 TWO WAY

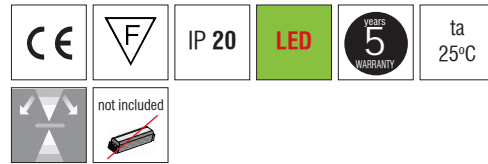
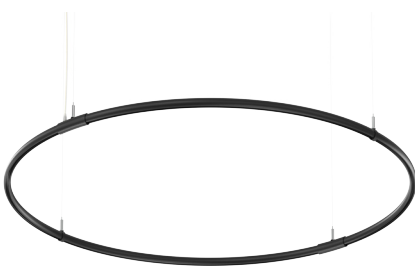

- Aluminium body, painted electrostatically in selected colour.
- Opal silicone cover (for up light).
- Suspension and power supply 2m included.
- Low voltage micro track end feed included.
- Luminous Efficacy (for up light):
144 Lm/W at 4000K - CRI: min. 90 / SDCM: 1
140 Lm/W at 3000K - CRI: min. 90 / SDCM: 1

Code	Description	Dimensions (mm)
8209711	Lite 1 Two Way 38W	∅ 800
8209712	Lite 2 Two Way 52W	∅1100
8209713	Lite 3 Two Way 69W	∅1450

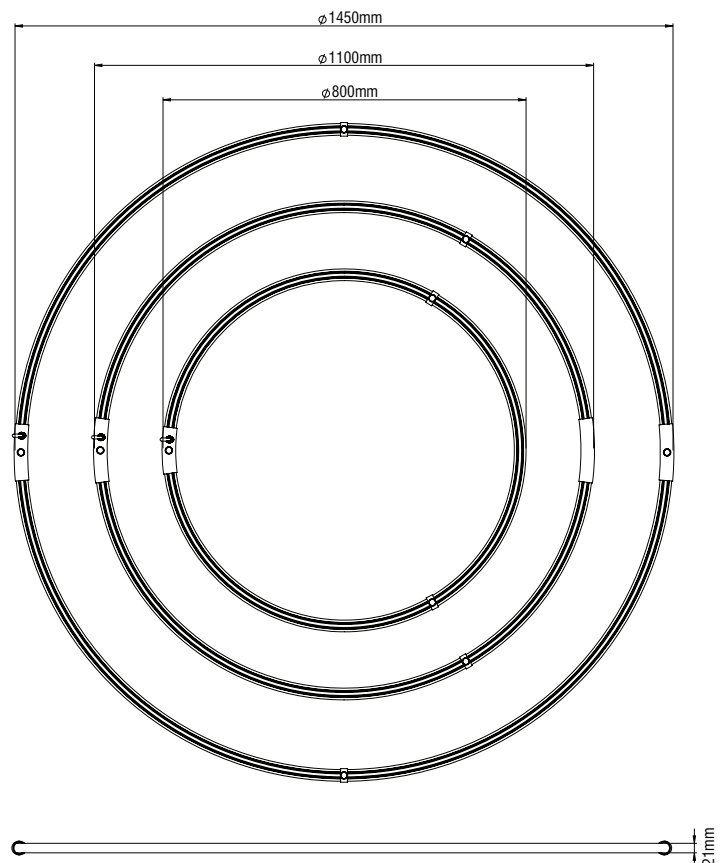

LED COLOUR CODES:	Colour Codes:
2 Warm 3 Neutral	1 White 3 Black

LITE

LITE SYSTEM TWO WAY L

Decorative Lighting

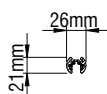
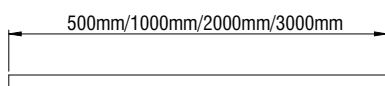

- Aluminium body, painted electrostatically in selected colour.
- Opal silicone cover (for up light).
- Suspension and power supply are not included.
- Low voltage micro track end feed not included.
- Luminous Efficacy (for up light):
144 Lm/W at 4000K - CRI: min. 90 / SDCM: 1
140 Lm/W at 3000K - CRI: min. 90 / SDCM: 1

Code	Description	Dimensions mm	
		L	W
8209721	Lite System Two Way L 500 7,5W	500	26
8209722	Lite System Two Way L 1000 15W	1000	26
8209723	Lite System Two Way L 2000 30W	2000	26
8209724	Lite System Two Way L 3000 45W	3000	26

LED COLOUR CODES:	Colour Codes:
2 Warm 3 Neutral	1 White 3 Black

LITE

Decorative Lighting

STRIPE LITE

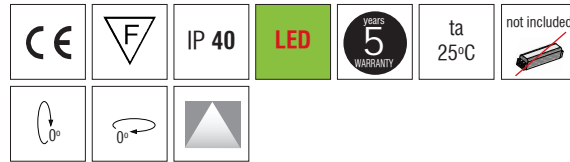
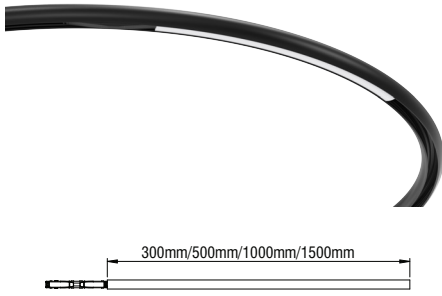

- Flexible led strip with low voltage 24V DC adapter.
- CRI: min. 90 / SDCM: 1
- Luminous efficacy:
4000 K: 144 Lm/Watt
3000 K: 140 Lm/Watt

Code	Description	L(mm)	Kg
8209731	Stripe Lite 24V DC 4,5W	300	0,300
8209732	Stripe Lite 24V DC 7,5W	500	0,400
8209733	Stripe Lite 24V DC 15W	1000	0,800
8209734	Stripe Lite 24V DC 22,5W	1500	1,200

DION GL

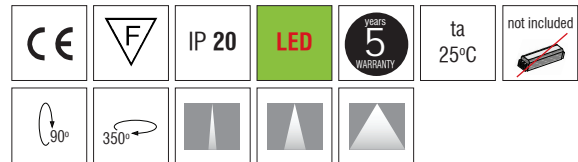
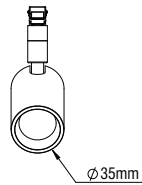
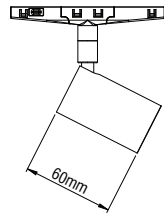

- Aluminium body.
- Lens in Spot, Medium & Wide version.
- With low voltage 24V DC adapter.
- CRI: min. 90 / SDCM: 3
- Luminous efficacy:
6W: 4000 K: 88 Lm/Watt
6W: 3000 K: 83 Lm/Watt

DION Q GL

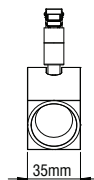
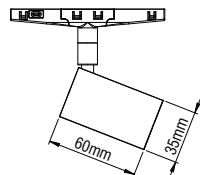

Code	Description	Kg
820951	Dion GL Track 24V DC 6W	0,150
820952	Dion Q GL Track 24V DC 6W	0,200

DION GL/DION Q GL: SPOT

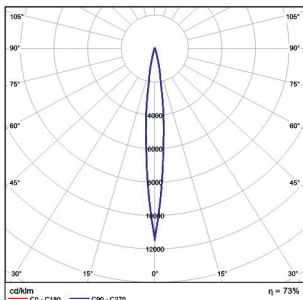

DION GL/DION Q GL: MEDIUM

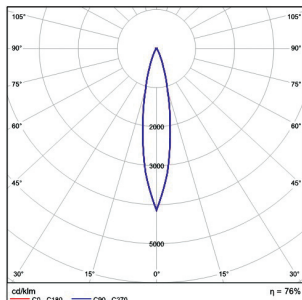

DION GL/DION Q GL: WIDE

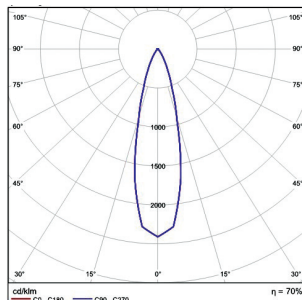

LED COLOUR CODES: 2 Warm 3 Neutral	BEAM CODES: 01 spot 02 medium 03 wide	Colour Codes: 0 Colours 1 White 2 Titan 3 Black
--	---	---

GALAXY ROSETTE AND SUSPENSION

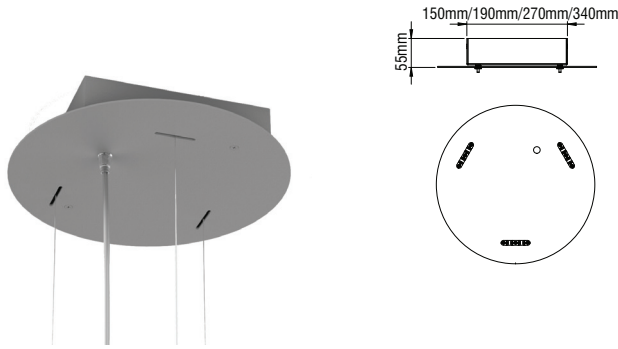

- For pendant use.
- Body from aluminium profile.
- Driver not included.

Code	Description
82050	Rosette Ø250*
82051	Rosette Ø300*
82052	Rosette Ø420**
82053	Rosette Ø500***

- * Can fit up to 9 single suspensions.
- ** Can fit up to 12 single suspensions.
- *** Can fit up to 15 single suspensions.

Colour Codes:			
0	Colours	1	White
2	Titan	3	Black

DRIVERS

Code	Description
800099	Driver 50W 24V DC
800098	Driver 100W 24V DC
800058	Driver 150W 24V DC
800150	Driver 250W 24V DC
800018	Driver 60W 24V DC Dimmer Dali / Push Button
800017	Driver 100W 24V DC Dimmer Dali / Push Button
800108	Driver 150W 24V DC Dimmer Dali / Push Button
800101	Driver 60W 24V DC Dimmer Phase cut
800102	Driver 100W 24V DC Dimmer Phase cut

ROSETTE AND DRIVER SELECTION

DESCRIPTION	ELECTRONIC		DIMMER		
	ROSETTE/CODE	DRIVER/CODE	ROSETTE/CODE	DRIVER (Dali/Push Button) /Code	DRIVER (Phase Cut) /Code
Lite 1 Two Way 38W	Ø250/82050x	50W/800099	Ø300/82051x	60W/800018	60W/800101
Lite 2 Two Way 52W	Ø250/82050x	100W/800098	Ø420/82052x	100W/800017	100W/800102
Lite 3 Two Way 69W	Ø300/82051x	150W/800058	Ø420/82052x	2x60W/2x800018	2x60W/2x800101

Colour Codes:			
0	Colours	1	White
2	Titan	3	Black

GALAXY ROSETTE MASIF AND SUSPENSION

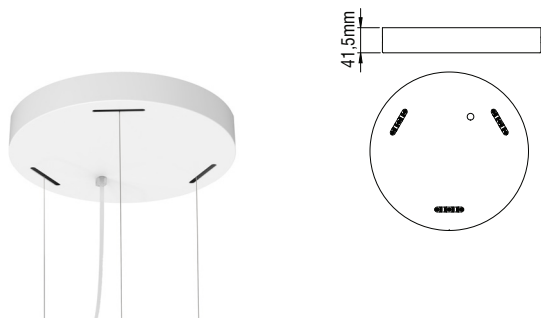

Colour Codes:

0 Colours 1 White 2 Titan 3 Black

- For pendant use.
- Body from aluminium.
- Driver not included.

Code	Description
82055	Rosette Masif Ø260*
82056	Rosette Masif Ø300**
82057	Rosette Masif Ø430***

- * Can fit up to 9 single suspensions.
- ** Can fit up to 12 single suspensions.
- *** Can fit up to 18 single suspensions.

DRIVERS

Code	Description
800099	Driver 50W 24V DC
800098	Driver 100W 24V DC
800058	Driver 150W 24V DC
800150	Driver 250W 24V DC
800018	Driver 60W 24V DC Dimmer Dali / Push Button
800017	Driver 100W 24V DC Dimmer Dali / Push Button
800108	Driver 150W 24V DC Dimmer Dali / Push Button
800101	Driver 60W 24V DC Dimmer Phase cut
800102	Driver 100W 24V DC Dimmer Phase cut

ROSETTE AND DRIVER SELECTION

DESCRIPTION	ELECTRONIC		DIMMER		
	ROSETTE/CODE	DRIVER/CODE	ROSETTE/CODE	DRIVER (Dali/Push Button) /Code	DRIVER (Phase Cut) /Code
Lite 1 Two Way 38W	Ø260/82055x	50W/800099	Ø260/82055x	60W/800018	60W/800101
Lite 2 Two Way 52W	Ø260/82055x	100W/800098	Ø300/82056x	100W/800017	100W/800102
Lite 3 Two Way 69W	Ø260/82055x	100W/800098	Ø300/82056x	100W/800017	100W/800102

Colour Codes:

0 Colours 1 White 2 Titan 3 Black

LITE

LITE END CAP



- End Cap made from aluminium in selected colour.

Code	Description
8039902	Lite End Cap (one piece)

END FEED with SUSPENSION (for LITE System)



- For pendant use.

Code	Description
82097411	End Feed with Suspension 1m
82097412	End Feed with Suspension 2m
82097413	End Feed with Suspension 3m

LITE SINGLE SUSPENSION



- For pendant use.

Code	Description
82097421	Lite Single Suspension 1m
82097422	Lite Single Suspension 2m
82097423	Lite Single Suspension 3m

SURFACE ROSETTE



- Body from aluminium profile.
- Square or round version.

Code	Description
8209405	Surface Rosette Ø100
8209406	Surface Rosette 100x100

RECESSED ROSETTE



- Body from aluminium profile.
- Square or round version.

Code	Description
8209407	Recessed Rosette Ø100
8209408	Recessed Rosette 100x100

Colour Codes:

0 Colours 1 White 2 Titan 3 Black

LITE

MIDDLE CONNECTOR



Code	Description
80394	Low Voltage Micro Track Middle Connector
80395	Low Voltage Micro Track Middle Connector 90°
80396	Low Voltage Micro Track Middle Connector 90° Surface - Wall
80397	Low Voltage Micro Track Middle Connector Adjustable

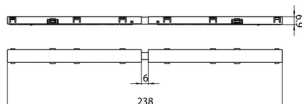
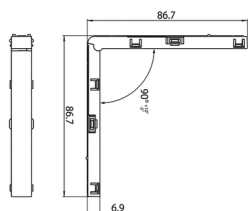
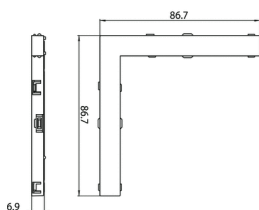
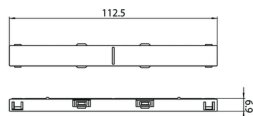

Colour Codes:

0 Colours 1 White 2 Titan 3 Black

ROSETTE LINEAR

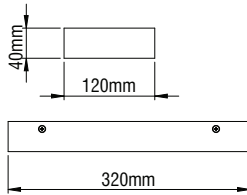

- Aluminium body.
- Driver and suspension not included.

Code	Description
8209402	Rosette Linear L 320mm
8209403	Rosette Linear L 420mm
8209404	Rosette Linear L 750mm

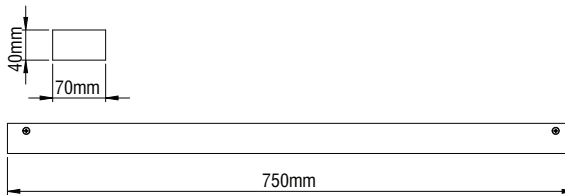
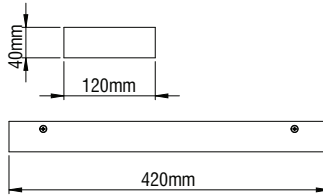

ROSETTE AND DRIVER SELECTION

DESCRIPTION Rosette / Code	ELECTRONIC DRIVER/Code	DIMMER	
		DRIVER (Dali/Push Button) /Code	DRIVER (Phase Cut) /Code
Rosette Linear L320mm/8209402	2x 60W/ 2x800097	2x 60W/ 2x800018	2x60W/ 2x800101
Rosette Linear L420mm/8209403	2x180W/ 2x800167	2x150W/ 2x800108	2x100W/ 2x800102
Rosette Linear L750mm/8209404	2x180W/ 2x800167	2x150W/ 2x800108	2x100W/ 2x800102

Colour Codes:

0 Colours 1 White 2 Titan 3 Black

LITE

Decorative Lighting

