

GALAXY TR is a 24V DC low voltage aluminium profile. It is an ideal solution for small showcases, homes, rest areas, museums, hotels, exhibition halls and generally for many decorative and architectural projects.

Technical Features

- Aluminium body, painted electrostatically in selected colour.
- With low voltage 24V DC micro track.

Tracking Lights

- With low voltage 24V DC adapter for mounting on LV micro track max. 10A (for linear parts) or max. 6A (for bented parts).
- Pure light without IR/UV radiation.
- Efficient thermal management.
- Operation life: 50,000 hours with efficiency > 80% of the initial luminous flux (L80B10).

Upon Request

- Available also in 2700 Kelvin CRI 90.

GALAXY TR

GALAXY TR 1 / GALAXY TR 1 TWO WAY

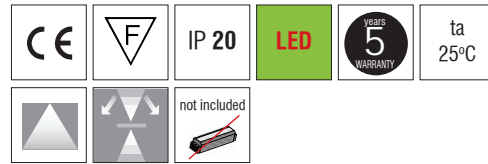

- Aluminium body, painted electrostatically in selected colour.
- Opal silicone cover (for up light).
- Suspension and power supply are not included.
- Low voltage micro track end feed included.
- Luminous Efficacy (for up light):
144 Lm/W at 4000K - CRI: min. 90 / SDCM: 1
140 Lm/W at 3000K - CRI: min. 90 / SDCM: 1

GALAXY TR 2 / GALAXY TR 2 TWO WAY

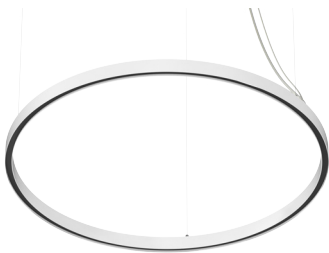

GALAXY TR 3 / GALAXY TR 3 TWO WAY

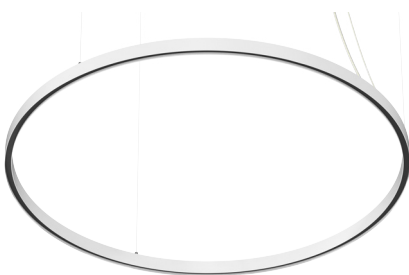

Code	Description
82093101	Galaxy TR 1
82093102	Galaxy TR 2
82093103	Galaxy TR 3
82093104	Galaxy TR 1 Two Way 38W
82093105	Galaxy TR 2 Two Way 57W
82093106	Galaxy TR 3 Two Way 71W

GALAXY TR 1 / GALAXY TR 1 TWO WAY

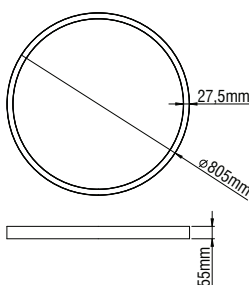

GALAXY TR 2 / GALAXY TR 2 TWO WAY

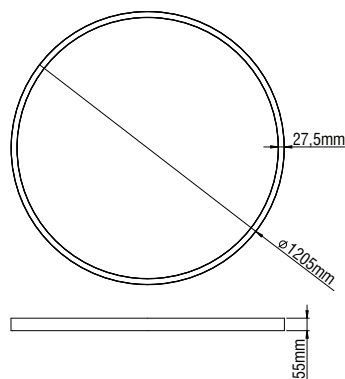

GALAXY TR 3 / GALAXY TR 3 TWO WAY

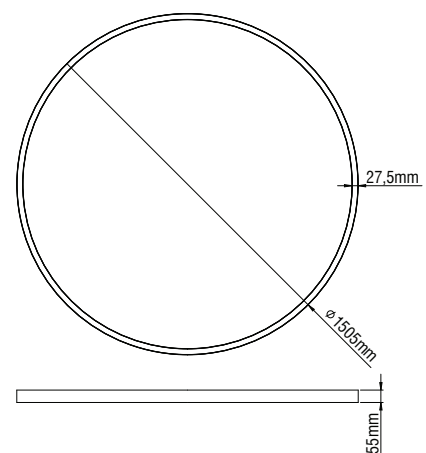

LED COLOUR CODES:	Colour Codes:
2 Warm 3 Neutral	0 Colours 1 White 2 Titan 3 Black

GALAXY TR

Decorative Lighting

GALAXY TR SYSTEM D

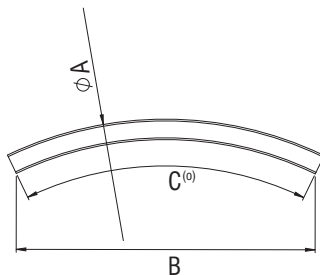
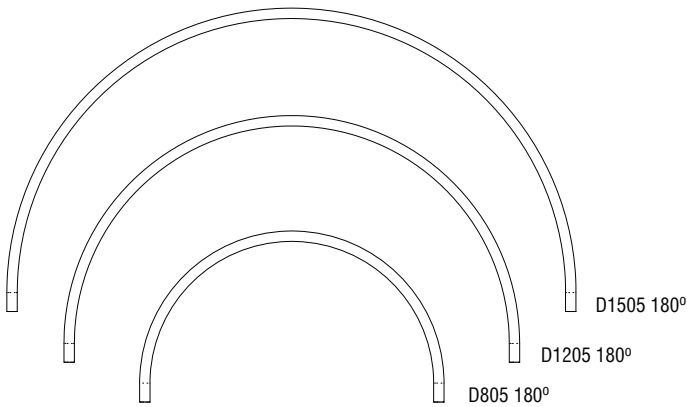
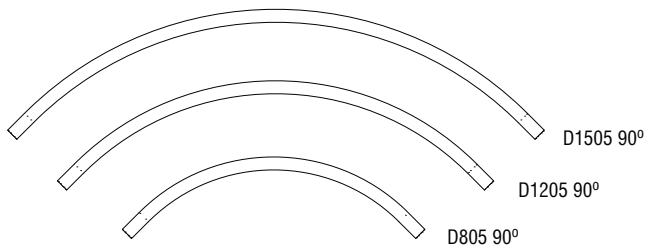
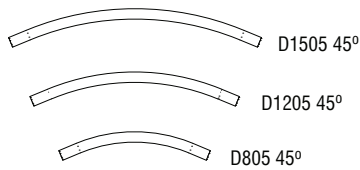
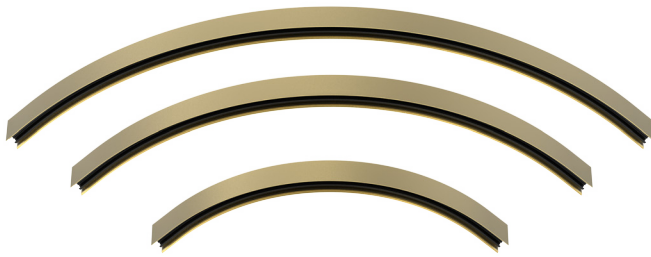

- Aluminium body, painted electrostatically in selected colour.
- Opal silicone cover (for up light).
- Suspension and power supply are not included.
- Low voltage micro track end feed not included.
- Luminous Efficacy (for up light):
144 Lm/W at 4000K - CRI: min. 90 / SDCM: 1
140 Lm/W at 3000K - CRI: min. 90 / SDCM: 1

Code	Description	Dimensions mm		
		ØA	B	C ^(°)
82093201	Galaxy TR System D 805- 45°	805 - 750	380	45
82093202	Galaxy TR System D 1205- 45°	1205 - 1150	530	45
82093203	Galaxy TR System D 1505- 45°	1505 - 1450	650	45
82093204	Galaxy TR System D 805- 90°	805 - 750	600	90
82093205	Galaxy TR System D 1205- 90°	1205 - 1150	885	90
82093206	Galaxy TR System D 1505- 90°	1505 - 1450	1100	90
82093207	Galaxy TR System D 805-180°	805 - 750	750	180
82093208	Galaxy TR System D 1205-180°	1205 - 1150	1150	180
82093209	Galaxy TR System D 1505-180°	1505 - 1450	1450	180

Code	Description	Dimensions mm		
		ØA	B	C ^(°)
82093210	Galaxy TR System Two Way D 805- 45° 5W	805 - 750	380	45
82093211	Galaxy TR System Two Way D 1205- 45° 7W	1205 - 1150	530	45
82093212	Galaxy TR System Two Way D 1505- 45° 9W	1505 - 1450	650	45
82093213	Galaxy TR System Two Way D 805- 90° 10W	805 - 750	600	90
82093214	Galaxy TR System Two Way D 1205- 90° 14W	1205 - 1150	885	90
82093215	Galaxy TR System Two Way D 1505- 90° 18W	1505 - 1450	1100	90
82093216	Galaxy TR System Two Way D 805-180° 19W	805 - 750	750	180
82093217	Galaxy TR System Two Way D 1205-180° 29W	1205 - 1150	1150	180
82093218	Galaxy TR System Two Way D 1505-180° 36W	1505 - 1450	1450	180

LED COLOUR CODES:

2 Warm 3 Neutral

Colour Codes:

0 Colours 1 White 2 Titan 3 Black

GALAXY TR

GALAXY TR SYSTEM L

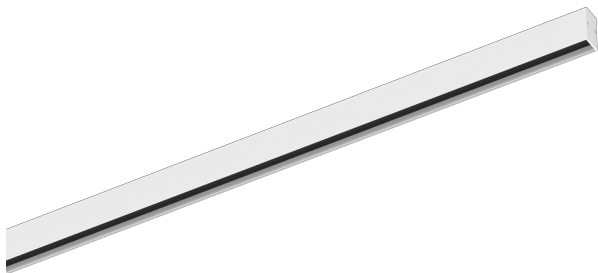

Decorative Lighting



- Aluminium body, painted electrostatically in selected colour.
- Opal silicone cover (for up light).
- Suspension and power supply are not included.
- Low voltage micro track end feed not included.
- Luminous Efficacy (for up light):
144 Lm/W at 4000K - CRI: min. 90 / SDCM: 1
140 Lm/W at 3000K - CRI: min. 90 / SDCM: 1

Code	Description	Dimensions mm		
		A	B	C
82093301	Galaxy TR System L 450	450	27,5	55
82093302	Galaxy TR System L 900	900	27,5	55
82093303	Galaxy TR System L 1350	1350	27,5	55
82093304	Galaxy TR System L 1800	1800	27,5	55
82093305	Galaxy TR System L 2250	2250	27,5	55

Code	Description	Dimensions mm		
		A	B	C
82093306	Galaxy TR System Two Way L 450 7W	450	27,5	55
82093307	Galaxy TR System Two Way L 900 14W	900	27,5	55
82093308	Galaxy TR System Two Way L 1350 20W	1350	27,5	55
82093309	Galaxy TR System Two Way L 1800 27W	1800	27,5	55
82093310	Galaxy TR System Two Way L 2250 34W	2250	27,5	55

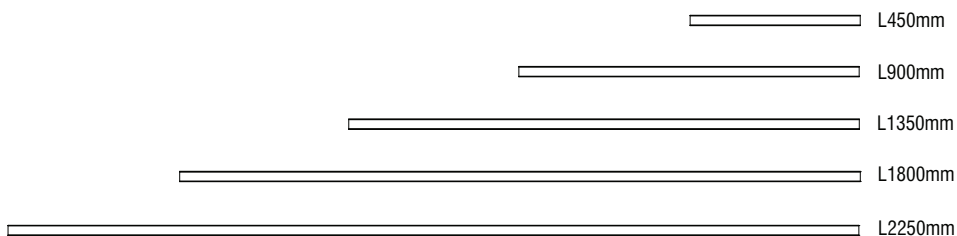
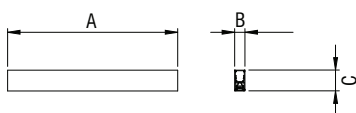

LED COLOUR CODES: 2 Warm 3 Neutral	Colour Codes: 0 Colours 1 White 2 Titan 3 Black
--	---

GALAXY TR

Decorative Lighting

DION GL

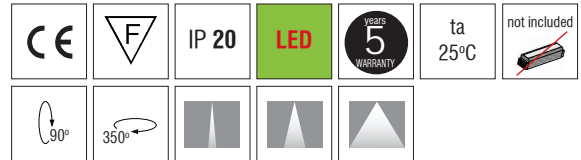
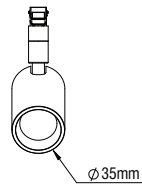
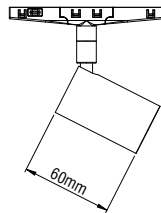

- Aluminium body.
- Lens in Spot, Medium & Wide version.
- With low voltage 24V DC adapter.
- CRI: min. 90 / SDCM: 3
- Luminous efficacy:
6W: 4000 K: 88 Lm/Watt
6W: 3000 K: 83 Lm/Watt

DION Q GL

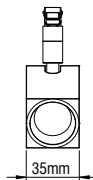
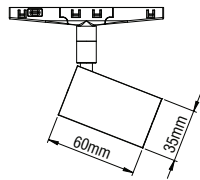

Code	Description	Kg
820951	Dion GL Track 24V DC 6W	0,150
820952	Dion Q GL Track 24V DC 6W	0,200

DION GL/DION Q GL: SPOT

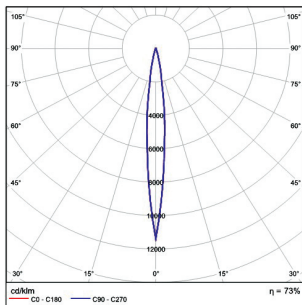

DION GL/DION Q GL: MEDIUM

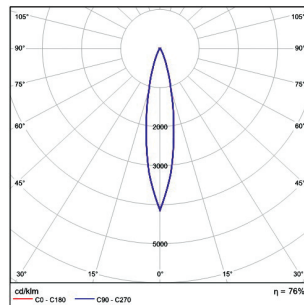

DION GL/DION Q GL: WIDE

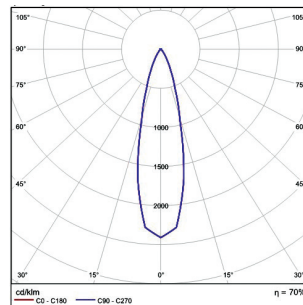

LED COLOUR CODES: 2 Warm 3 Neutral	BEAM CODES: 01 spot 02 medium 03 wide	Colour Codes: 0 Colours 1 White 2 Titan 3 Black
--	---	---

STRIPE ARC GL

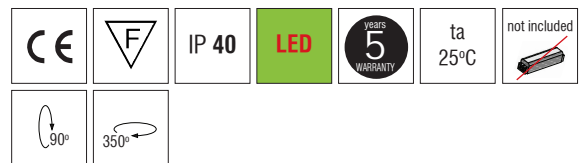
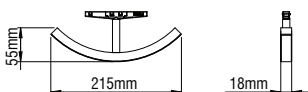

- Aluminium body.
- With low voltage 24V DC adapter.
- CRI: min. 80 / SDCM: 3
- Luminous efficacy:
4000 K: 144 Lm/Watt
3000 K: 140 Lm/Watt

Code	Description	Kg
820953	Stripe Arc GL Track 24V DC 4W	0,100

LED COLOUR CODES: 2 Warm 3 Neutral	Colour Codes: 0 Colours 1 White 2 Titan 3 Black
--	---

GALAXY TR

Decorative Lighting

STRIPE GL

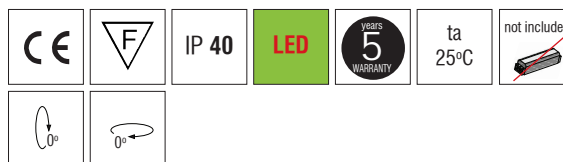
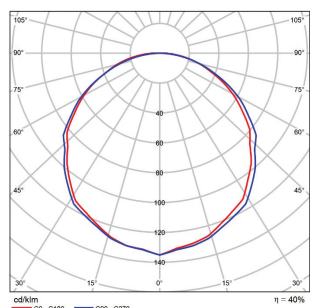
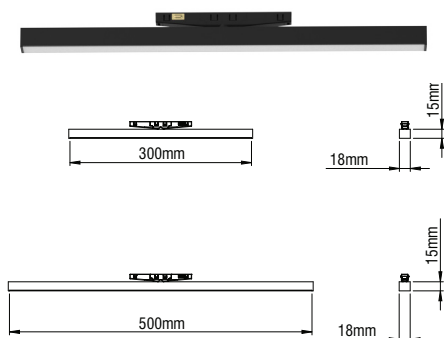

- Aluminium body.
- With low voltage 24V DC adapter.
- CRI: min. 80 / SDCM: 3
- Luminous efficacy:
4000 K: 144 Lm/Watt
3000 K: 140 Lm/Watt

Code	Description	L(mm)	Kg
820954	Stripe GL Track 24V DC 5W	300	0,300
820955	Stripe GL Track 24V DC 8W	500	0,400

STRIPE ANGLE BEND GL

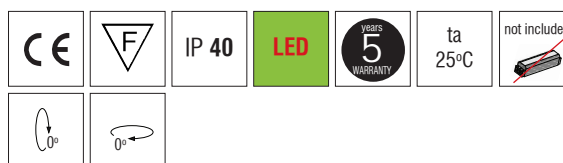
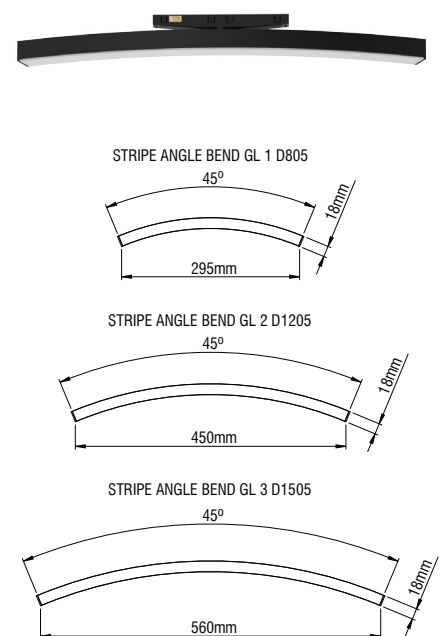

- Aluminium body.
- With low voltage 24V DC adapter.
- CRI: min. 80 / SDCM: 3
- Luminous efficacy:
4000 K: 144 Lm/Watt
3000 K: 140 Lm/Watt

Code	Description
820956	Stripe Angle Bend GL1 Track 24V DC 5W
820957	Stripe Angle Bend GL2 Track 24V DC 7W
820958	Stripe Angle Bend GL3 Track 24V DC 9W

LED COLOUR CODES:	Colour Codes:
2 Warm 3 Neutral	0 Colours 1 White 2 Titan 3 Black

GALAXY TR

Decorative Lighting

GALAXY ROSETTE AND SUSPENSION

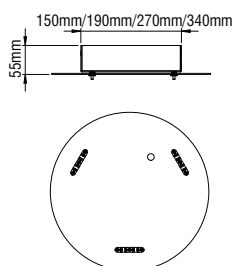
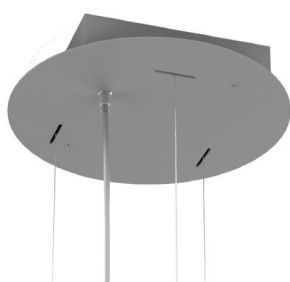

- For pendant use.
- Body from aluminium profile.
- Driver and suspensions not included.

Code	Description
82050	Rosette Ø250
82051	Rosette Ø300
82052	Rosette Ø420
82053	Rosette Ø500
900101	Single Suspension Morfi 1m (3 pieces needed)*
900103	Single Suspension Morfi 2m (3 pieces needed)*
900104	Single Suspension Morfi 3m (3 pieces needed)*
900105	Single Suspension Morfi 4m (3 pieces needed)*

* For installation at the rosette

Colour Codes:

0 Colours 1 White 2 Titan 3 Black

DRIVERS

Code	Description
800099	Driver 50W 24V DC
800098	Driver 100W 24V DC
800058	Driver 150W 24V DC
800150	Driver 250W 24V DC
800018	Driver 60W 24V DC Dimmer Dali / Push Button
800017	Driver 100W 24V DC Dimmer Dali / Push Button
800108	Driver 150W 24V DC Dimmer Dali / Push Button
800101	Driver 60W 24V DC Dimmer Phase cut
800102	Driver 100W 24V DC Dimmer Phase cut

ROSETTE AND DRIVER SELECTION

DESCRIPTION	ELECTRONIC		DIMMER		
	ROSETTE/CODE	DRIVER/CODE	ROSETTE/CODE	DRIVER (Dali/Push Button) /Code	DRIVER (Phase Cut) /Code
Galaxy TR 1 Two Way 38W	Ø250/82050x	50W/800099	Ø300/82051x	60W/800018	60W/800101
Galaxy TR 2 Two Way 57W	Ø250/82050x	100W/800098	Ø420/82052x	100W/800017	100W/800102
Galaxy TR 3 Two Way 71W	Ø300/82051x	150W/800058	Ø420/82052x	2x60W/2x800018	2x60W/2x800101

Colour Codes:

0 Colours 1 White 2 Titan 3 Black

GALAXY TR

Decorative Lighting

GALAXY ROSETTE MASIF AND SUSPENSION

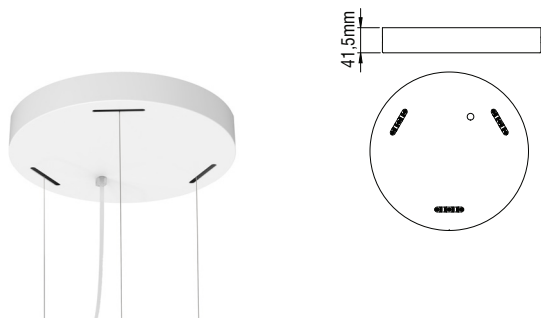

- For pendant use.
- Body from aluminium.
- Driver and suspensions not included.

Code	Description
82055	Rosette Masif Ø260
82056	Rosette Masif Ø300
82057	Rosette Masif Ø430
900101	Single Suspension Morfi 1m (3 pieces needed)*
900103	Single Suspension Morfi 2m (3 pieces needed)*
900104	Single Suspension Morfi 3m (3 pieces needed)*
900105	Single Suspension Morfi 4m (3 pieces needed)*

* For installation at the rosette

Colour Codes:

0 Colours 1 White 2 Titan 3 Black

DRIVERS

Code	Description
800099	Driver 50W 24V DC
800098	Driver 100W 24V DC
800058	Driver 150W 24V DC
800150	Driver 250W 24V DC
800018	Driver 60W 24V DC Dimmer Dali / Push Button
800017	Driver 100W 24V DC Dimmer Dali / Push Button
800108	Driver 150W 24V DC Dimmer Dali / Push Button
800101	Driver 60W 24V DC Dimmer Phase cut
800102	Driver 100W 24V DC Dimmer Phase cut

ROSETTE AND DRIVER SELECTION

DESCRIPTION	ELECTRONIC		DIMMER		
	ROSETTE/CODE	DRIVER/CODE	ROSETTE/CODE	DRIVER (Dali/Push Button) /Code	DRIVER (Phase Cut) /Code
Galaxy TR 1 Two Way 38W	Ø260/82055x	50W/800099	Ø260/82055x	60W/800018	60W/800101
Galaxy TR 2 Two Way 57W	Ø260/82055x	100W/800098	Ø300/82056x	100W/800017	100W/800102
Galaxy TR 3 Two Way 71W	Ø260/82055x	100W/800098	Ø300/82056x	100W/800017	100W/800102

Colour Codes:

0 Colours 1 White 2 Titan 3 Black

GALAXY TR

GALAXY END CAP



- End Cap made from aluminium in selected colour.

Code	Description
8209401	Galaxy End Cap (pair)

SINGLE SUSPENSION



- For pendant use.

Code	Description
900112	Single Suspension 1m*
900114	Single Suspension 2m*
900116	Single Suspension 3m*

* For installation at the ceiling

SURFACE ROSETTE



- Body from aluminium profile.
- Square or round version.

Code	Description
8209405	Surface Rosette Ø100
8209406	Surface Rosette 100x100

RECESSED ROSETTE



- Body from aluminium profile.
- Square or round version.

Code	Description
8209407	Recessed Rosette Ø100
8209408	Recessed Rosette 100x100

Colour Codes:

0 Colours 1 White 2 Titan 3 Black

GALAXY TR

END FEED

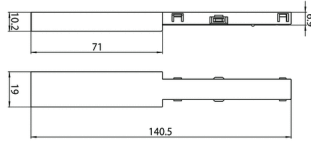
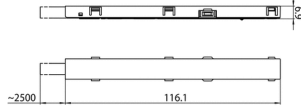

MIDDLE CONNECTOR

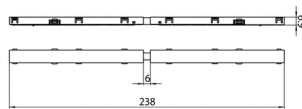
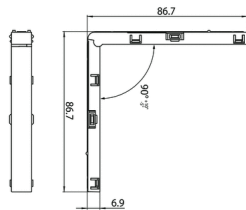
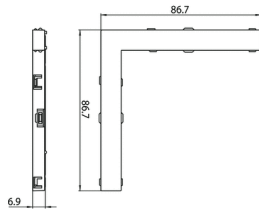
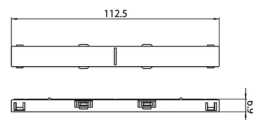

Code	Description
80392	Low Voltage Micro Track Linear End Feed
80393	Low Voltage Micro Track End Feed



Code	Description
80394	Low Voltage Micro Track Middle Connector
80395	Low Voltage Micro Track Middle Connector 90°
80396	Low Voltage Micro Track Middle Connector 90° Surface - Wall
80397	Low Voltage Micro Track Middle Connector Adjustable

Colour Codes:

0 Colours 1 White 2 Titan 3 Black

GALAXY TR

Decorative Lighting

ROSETTE LINEAR

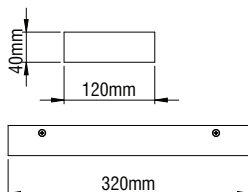

- Aluminium body.
- Driver and suspension not included.

Code	Description
8209402	Rosette Linear L 320mm*
8209403	Rosette Linear L 420mm*
8209404	Rosette Linear L 750mm*

* Can fit one piece of Morfi Suspension

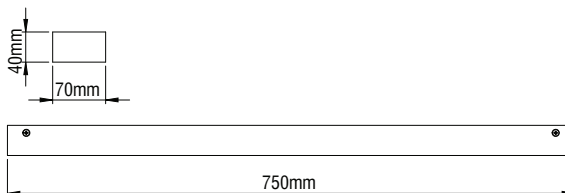
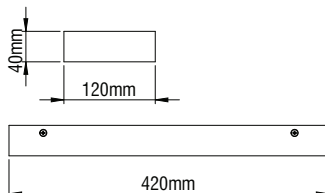

ROSETTE AND DRIVER SELECTION

DESCRIPTION Rosette / Code	ELECTRONIC DRIVER/Code	DIMMER	
		DRIVER (Dali/Push Button) /Code	DRIVER (Phase Cut) /Code
Rosette Linear L320mm/8209402	2x 60W/ 2x800097	2x 60W/ 2x800018	2x60W/ 2x800101
Rosette Linear L420mm/8209403	2x180W/ 2x800167	2x150W/ 2x800108	2x100W/ 2x800102
Rosette Linear L750mm/8209404	2x180W/ 2x800167	2x150W/ 2x800108	2x100W/ 2x800102

Colour Codes:

0 Colours 1 White 2 Titan 3 Black

